

---

**PART C-1**  
**FALL RESTRAINT AND FALL ARREST**

**WAC 296-155-245 Reserved.**

[Statutory Authority: Chapter 49.17 RCW. 96-24-051, (Order 96-05), § 296-155-245, filed 11/27/96, effective 02/01/97. 95-10-016, § 296-155-245, filed 4/25/95, effective 10/1/95.]

**WAC 296-155-24501 Scope and application.**

This section sets forth requirements for employers to provide and enforce the use of fall protection for employees in construction, alteration, repair, maintenance (including painting and decorating), demolition workplaces, and material handling covered under chapter 296-155 WAC.

*Note: See Appendix B for additional standards that require the use of fall restraint and/or fall arrest protection.*

[Statutory Authority: RCW 49.17.010, .040, .050, .00-14-058, (Order 99-43), § 296-155-24501, filed 07/03/2000, effective 10/01/2000. Statutory Authority: Chapter 49.17 RCW. 96-24-051, (Order 96-05), § 296-155-24501, filed 11/27/96, effective 02/01/97. 95-10-016, § 296-155-24501, filed 4/25/95, effective 10/1/95; 91-03-044 (Order 90-18), § 296-155-24501, filed 1/10/91, effective 2/12/91.]

**WAC 296-155-24503 Definitions.**

**“Anchorage”** means a secure point of attachment for lifelines, lanyards, or deceleration devices which is capable of withstanding the forces specified in the applicable sections of chapter 296-155 WAC.

**“Approved”** means, for the purpose of this section; tested and certified by the manufacturer, or any recognized national testing laboratory, to possess the strength requirements specified in this section.

**“Body belt”** means a Type 1 safety belt used in conjunction with lanyard or lifeline for fall restraint only.

**“Full body harness”** means a configuration of connected straps to distribute a fall arresting force over at least the thighs, shoulders and pelvis, with provisions for attaching a lanyard, lifeline, or deceleration devices.

**“Full body harness system”** means a Class III full body harness and lanyard which is attached to an anchorage meeting the requirements of chapter 296-155 WAC, Part C-1; or attached to a horizontal or vertical lifeline which is properly secured to an anchorage(s) capable of withstanding the forces specified in the applicable sections of chapter 296-155 WAC.

**“Catenary line”** - see horizontal lifeline.

**“Competent person”** means an individual knowledgeable of fall protection equipment, including the manufacturers recommendations and instructions for the proper use, inspection, and maintenance; and who is capable of identifying existing and potential fall hazards; and who has the authority to take prompt corrective action to eliminate those hazards; and who is knowledgeable of the rules contained in this section regarding the erection, use, inspection, and maintenance of fall protection equipment and systems.

**“Connector”** means a device which is used to couple (connect) parts of the personal fall arrest system and positioning device systems together. It may be an independent component of the system, such as a carabiner, or it may be an integral component of part of the system (such as a buckle or dee ring sewn into a body belt or body harness, or a snap hook spliced or sewn to a lanyard or self-retracting lanyard).

**“Continuous fall protection”** means the design and use of a fall protection system such that no exposure to an elevated fall hazard occurs. This may require more than one fall protection system or a combination of prevention or protection measures.

**“Control zone”** means the area between the warning line and the unprotected sides and edges of the walking/working surface.

---

**WAC 296-155-24503 (Cont.)**

**“Deceleration device”** means any mechanism, such as a rope grab, ripstitch lanyard, specifically woven lanyard, tearing or deforming lanyards, automatic self-retracting lifelines/lanyards, etc., which serves to dissipate a substantial amount of energy during a fall arrest, or otherwise limit the energy imposed on an employee during fall arrest.

**“Deceleration distance”** means the additional vertical distance a falling employee travels, excluding lifeline elongation and free fall distance, before stopping, from the point at which the deceleration device begins to operate. It is measured as the distance between the location of an employee's body belt or body harness attachment point at the moment of activation (at the onset of fall arrest forces) of the deceleration device during a fall, and the location of that attachment point after the employee comes to a full stop.

**“Drop line”** means a vertical lifeline secured to an upper anchorage for the purpose of attaching a lanyard or device.

**“Failure”** means load refusal, breakage, or separation of component parts. Load refusal is the point where the ultimate strength is exceeded.

**“Fall arrest system”** means the use of multiple, approved safety equipment components such as; body harnesses, lanyards, deceleration devices, droplines, horizontal and/or vertical lifelines and anchorages, interconnected and rigged as to arrest a free fall. Compliance with anchorage strength requirements specified in the applicable sections of chapter 296-155 WAC, Part C-1 shall constitute approval of the anchorage.

**“Fall protection work plan”** means a written planning document in which the employer identifies all areas on the job site where a fall hazard of 10 feet or greater exists. The plan describes the method or methods of fall protection to be utilized to protect employees, and includes the procedures governing the installation use, inspection, and removal of the fall protection method or methods which are selected by the employer. (See WAC 296-155-24505.)

**“Fall restraint system”** means an approved device and any necessary components that function together to restrain an employee in such a manner as to prevent that employee from falling to a lower level. When standard guardrails are selected, compliance with applicable sections governing their construction and use shall constitute approval.

**“Fall distance”** means the actual distance from the workers support to the level where a fall would stop.

**“Free fall”** means the act of falling before a personal fall arrest system begins to apply force to arrest the fall.

**“Free fall distance”** means the vertical displacement of the fall arrest attachment point on the employee's body belt or body harness between onset of the fall and just before the system begins to apply force to arrest the fall. This distance excludes deceleration distance, and lifeline/lanyard elongation, but includes any deceleration device slide distance or self-retracting lifeline/lanyard extension before they operate and fall arrest forces occur.

**“Hardware”** means snap hooks, D rings, bucklers, carabiners, adjusters, O rings, that are used to attach the components of a fall protection system together.

**“Horizontal lifeline”** means a rail, rope, wire, or synthetic cable that is installed in a horizontal plane between two anchorages and used for attachment of a workers lanyard or lifeline device while moving horizontally; used to control dangerous pendulum like swing falls.

**“Lanyard”** means a flexible line of webbing, rope, or cable used to secure a body belt or harness to a lifeline or an anchorage point usually 2, 4, or 6 feet long.

---

**WAC 296-155-24503 (Cont.)**

**“Leading edge”** means the advancing edge of a floor, roof, or formwork which changes location as additional floor, roof, or formwork sections are placed, formed, or constructed. Leading edges not actively under construction are considered to be "unprotected sides and edges, and positive methods of fall arrest or fall restraint shall be required to protect exposed workers.

**“Lifeline”** means a vertical line from a fixed anchorage or between two horizontal anchorages, independent of walking or working surfaces, to which a lanyard or device is secured. Lifeline as referred to in this text is one which is part of a fall protection system used as back-up safety for an elevated worker.

**“Locking snap hook”** means a connecting snap hook that requires two separate forces to open the gate; one to deactivate the gatekeeper and a second to depress and open the gate which automatically closes when released; used to minimize roll out or accidental disengagement.

**“Low pitched roof”** means a roof having a slope equal to or less than 4 in 12.

**“Mechanical equipment”** means all motor or human propelled wheeled equipment except for wheelbarrows, mopcars, robotic thermoplastic welders and robotic crimpers.

**“Positioning belt”** means a single or multiple strap that can be secured around the workers body to hold the user in a work position; for example, a linemans belt, a rebar belt, or saddle belt.

**“Positioning device system”** means a body belt or body harness system rigged to allow an employee to be supported on an elevated vertical surface, such as a wall, and work with both hands free while leaning.

**“Restraint line”** means a line from a fixed anchorage or between two anchorages to which an employee is secured in such a way as to prevent the worker from falling to a lower level.

**“Roll out”** means unintentional disengagement of a snap hook caused by the gate being depressed under torque or contact while twisting or turning; a particular concern with single action snap hooks that do not have a locking gatekeeper.

**“Roof”** means the exterior surface on the top of a building. This does not include floors or form work which, because a building has not been completed, temporarily become the top surface of a building.

**“Roofing work”** means the hoisting, storage, application, and removal of roofing materials and equipment, including related insulation, sheet metal, and vapor barrier work, but not including the construction of the roof deck.

**“Rope grab”** means a fall arrester that is designed to move up or down a lifeline suspended from a fixed overhead or horizontal anchorage point, or lifeline, to which the belt or harness is attached. In the event of a fall, the rope grab locks onto the lifeline rope through compression to arrest the fall. The use of a rope grab device is restricted for all restraint applications. (Refer to WAC 296-155-24510 (1)(b)(iii)).

**“Safety line”** - see lifeline.

**“Safety monitor system”** means a system of fall restraint used in conjunction with a warning line system only, where a competent person as defined by this part, having no additional duties, monitors the proximity of workers to the fall hazard when working between the warning line and the unprotected sides and edges including, the leading edge of a low pitched roof or walking/working surface.

---

**WAC 296-155-24503 (Cont.)**

“**Self retracting lifeline**” means a deceleration device which contains a drum wound line which may be slowly extracted from, or retracted onto, the drum under slight tension during normal employee movement, and which after onset of a fall, automatically locks the drum and arrests the fall.

“**Shock absorbing lanyard**” means a flexible line of webbing, cable, or rope used to secure a body belt or harness to a lifeline or anchorage point that has an integral shock absorber.

“**Single action snap hook**” means a connecting snap hook that requires a single force to open the gate which automatically closes when released.

“**Snap hook**” means a self-closing connecting device with a gatekeeper latch or similar arrangement that will remain closed until manually opened. This includes single action snap hooks that open when the gatekeeper is depressed and double action snap hooks that require a second action on a gatekeeper before the gate can be opened.

“**Static line**” - see horizontal lifeline.

“**Strength member**” means any component of a fall protection system that could be subject to loading in the event of a fall.

“**Steep roof**” means a roof having a slope greater than 4 in 12.

“**Unprotected sides and edges**” means any side or edge (except at entrances to points of access) of a floor, roof, ramp or runway where there is no wall or guardrail system as defined in WAC 296-155-505(7).

“**Walking/working surface**” means for the purpose of this section, any area whose dimensions are 45 inches or greater in all directions, through which workers pass or conduct work.

“**Warning line system**” means a barrier erected on a walking and working surface or a low pitch roof (4 in 12 or less), to warn employees that they are approaching an unprotected fall hazard(s).

“**Work area**” means that portion of a walking/working surface where job duties are being performed.  
[Statutory Authority: RCW 49.17.010, .040, .050. 00-14-058 (Order 99-43), § 296-155-24503, filed 07/03/2000, effective 10/01/2000. Statutory Authority: Chapter 49.17 RCW. 96-24-051, (Order 96-05), § 296-155-24503, filed 11/27/96, effective 02/01/97. 95-10-016, § 296-155-24503, filed 4/25/95, effective 10/1/95; 91-03-044 (Order 90-18), § 296-155-24503, filed 1/10/91, effective 2/12/91.]

**WAC 296-155-24505 Fall protection work plan.**

- (1) The employer shall develop and implement a written fall protection work plan including each area of the work place where the employees are assigned and where fall hazards of 10 feet or more exist.
- (2) The fall protection work plan shall:
  - (a) Identify all fall hazards in the work area.
  - (b) Describe the method of fall arrest or fall restraint to be provided.
  - (c) Describe the correct procedures for the assembly, maintenance, inspection, and disassembly of the fall protection system to be used.
  - (d) Describe the correct procedures for the handling, storage, and securing of tools and materials.

---

**WAC 296-155-24505 (Cont.)**

- (e) Describe the method of providing overhead protection for workers who may be in, or pass through the area below the work site.
  - (f) Describe the method for prompt, safe removal of injured workers.
  - (g) Be available on the job site for inspection by the department.
- (3) Prior to permitting employees into areas where fall hazards exist the employer shall:
- (a) Ensure that employees are trained and instructed in the items described in subsection (2)(a) through (f) of this section.
  - (b) Inspect fall protection devices and systems to ensure compliance with WAC 296-155-24510.
- (4) Training of employees:
- (a) The employer shall ensure that employees are trained as required by this section. Training shall be documented and shall be available on the job site.
  - (b) “Retraining.” When the employer has reason to believe that any affected employee who has already been trained does not have the understanding and skill required by subsection (1) of this section, the employer shall retrain each such employee. Circumstances where retraining is required include, but are not limited to, situations where:
    - Changes in the workplace render previous training obsolete; or
    - Changes in the types of fall protection systems or equipment to be used render previous training obsolete; or
    - Inadequacies in an affected employee’s knowledge or use of fall protection systems or equipment indicate that the employee has not retained the requisite understanding or skill.

*Note: The following appendices to Part C-1 of this chapter serve as nonmandatory guidelines to assist employers in complying with the appropriate requirements of Part C-1 of this chapter.*

[Statutory Authority: RCW 49.17.010, .040, .050. 00-14-058 (Order 99-43), § 296-155-24505, filed 07/03/00, effective 10/01/00. Statutory Authority: Chapter 49.17 RCW. 96-24-051, (Order 96-05), § 296-155-24505, filed 11/27/96, effective 02/01/97. 95-10-016, § 296-155-24505, filed 4/25/95, effective 10/1/95; 91-03-044 (Order 90-18), § 296-155-24505, filed 1/10/91, effective 2/12/91.]

**WAC 296-155-24507 Reserved.**

[Statutory Authority: 96-24-051, (Order 96-05), § 296-155-24507, filed 11/27/96, effective 02/01/97. 95-10-016, § 296-155-24507, filed 4/25/95, effective 10/1/95.]

**WAC 296-155-24510 Fall restraint, fall arrest systems.**

When employees are exposed to a hazard of falling from a location 10 feet or more in height, the employer shall ensure that fall restraint, fall arrest systems or positioning device systems are provided, installed, and implemented according to the following requirements.

WAC 296-155-24510 (Cont.)

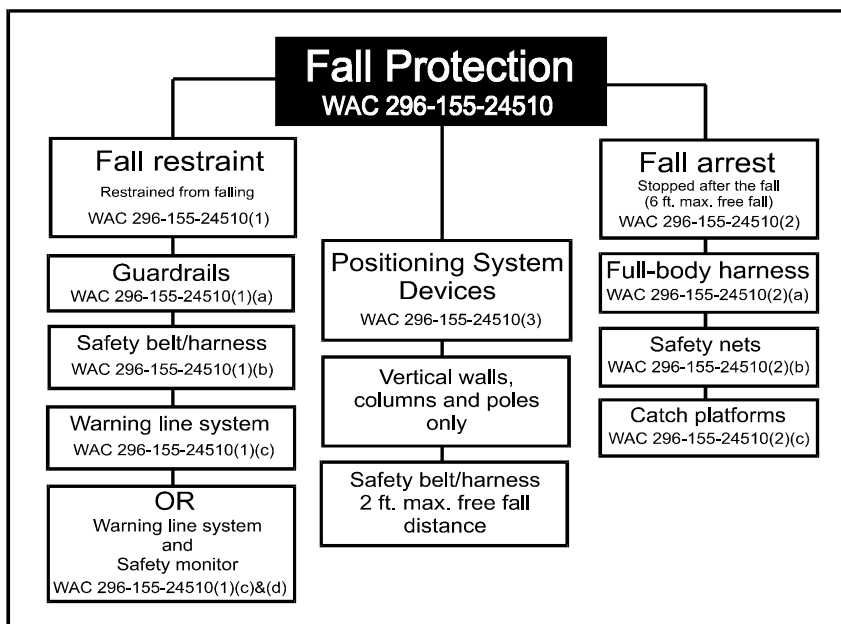
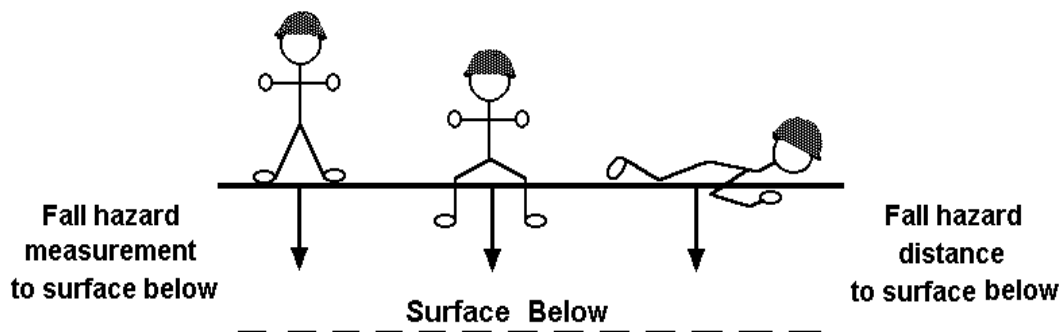

- (1) Fall restraint protection shall consist of:
- (a) Standard guardrails as described in chapter 296-155 WAC, Part K.
  - (b) Safety belts and/or harness attached to securely rigged restraint lines.
    - (i) Safety belts and/or harness shall conform to ANSI Standard:
      - Class I body belt
      - Class II chest harness
      - Class III full body harness
      - Class IV suspension/position belt
    - (ii) All safety belt and lanyard hardware assemblies shall be capable of withstanding a tensile loading of 4,000 pounds without cracking, breaking, or taking a permanent deformation.

---

**WAC 296-155-24510 (Cont.)**

- (iii) Rope grab devices are prohibited for fall restraint applications unless they are part of a fall restraint system designed specifically for the purpose by the manufacturer, and used in strict accordance with the manufacturers recommendations and instructions.
  - (iv) The employer shall ensure component compatibility.
  - (v) Components of fall restraint systems shall be inspected prior to each use for mildew, wear, damage, and other deterioration, and defective components shall be removed from service if their function or strength have been adversely affected.
  - (vi) Anchorage points used for fall restraint shall be capable of supporting 4 times the intended load.
  - (vii) Restraint protection shall be rigged to allow the movement of employees only as far as the sides and edges of the walking/working surface.
- (c) A warning line system as prescribed in WAC 296-155-24515(3) and supplemented by the use of a safety monitor system as prescribed in WAC 296-155-24521 to protect workers engaged in duties between the forward edge of the warning line and the unprotected sides and edges, including the leading edge, of a low pitched roof or walking/working surface.
- (d) Warning line and safety monitor systems as described in WAC 296-155-24515 (3) through (4)(f) and WAC 296-155-24520 respectively are prohibited on surfaces exceeding a 4 in 12 pitch, and on any surface whose dimensions are less than 45 inches in all directions.
- (2) Fall arrest protection shall consist of:
- (a) Full body harness system.
    - (i) An approved Class III full body harness shall be used.
    - (ii) Body harness systems or components subject to impact loading shall be immediately removed from service and shall not be used again for employee protection unless inspected and determined by a competent person to be undamaged and suitable for reuse.
    - (iii) All safety lines and lanyards shall be protected against being cut or abraded.
    - (iv) The attachment point of the body harness shall be located in the center of the wearer's back near shoulder level, or above the wearer's head.
    - (v) Body harness systems shall be rigged to minimize free fall distance with a maximum free fall distance allowed of 6 feet, and such that the employee will not contact any lower level.
    - (vi) Hardware shall be drop forged, pressed or formed steel, or made of materials equivalent in strength.
    - (vii) Hardware shall have a corrosion resistant finish, and all surfaces and edges shall be smooth to prevent damage to the attached body harness or lanyard.
    - (viii) When vertical lifelines (droplines) are used, not more than one employee shall be attached to any one lifeline.

---

**WAC 296-155-24510 (Cont.)**

*Note: The system strength needs in the following items are based on a total combined weight of employee and tools of no more than 310 pounds. If combined weight is more than 310 pounds, appropriate allowances must be made or the system will not be deemed to be in compliance.*

- (ix) Full body harness systems shall be secured to anchorages capable of supporting 5,000 pounds per employee except: When self retracting lifelines or other deceleration devices are used which limit free fall to two feet, anchorages shall be capable of withstanding 3,000 pounds.
- (x) Vertical lifelines (droplines) shall have a minimum tensile strength of 5,000 pounds (22.2 kN), except that self retracting lifelines and lanyards which automatically limit free fall distance to two feet (.61 m) or less shall have a minimum tensile strength of 3,000 pounds (13.3 kN).
- (xi) Horizontal lifelines shall be designed, installed, and used, under the supervision of a qualified person, as part of a complete personal fall arrest system, which maintains a safety factor of at least two.
- (xii) Lanyards shall have a minimum tensile strength of 5,000 pounds (22.2 kN).
- (xiii) All components of body harness systems whose strength is not otherwise specified in this subsection shall be capable of supporting a minimum fall impact load of 5,000 pounds (22.2 kN) applied at the lanyard point of connection.
- (xiv) Dee-rings and snap-hooks shall be proof-tested to a minimum tensile load of 3,600 pounds (16 kN) without cracking, breaking, or taking permanent deformation.
- (xv) Snap-hooks shall be a locking type snap-hook designed and used to prevent disengagement of the snap-hook by the contact of the snap-hook keeper by the connected member.
- (xvi) Unless the snap-hook is designed for the following connections, snap-hooks shall not be engaged:
  - (A) Directly to the webbing, rope or wire rope;
  - (B) To each other;
  - (C) To a dee-ring to which another snap-hook or other connector is attached;
  - (D) To a horizontal lifeline; or
  - (E) To any object which is incompatibly shaped or dimensioned in relation to the snap-hook such that unintentional disengagement could occur by the connected object being able to depress the snap-hook keeper and release itself.
- (xvii) Full body harness systems shall be inspected prior to each use for mildew, wear, damage, and other deterioration, and defective components shall be removed from service if their function or strength have been adversely affected.

**WAC 296-155-24510 (Cont.)**

- (b) Safety net systems. Safety net systems and their use shall comply with the following provisions:
  - (i) Safety nets shall be installed as close as practicable under the surface on which employees are working, but in no case more than 30 feet (9.1 m) below such level unless specifically approved in writing by the manufacturer. The potential fall area to the net shall be unobstructed.
  - (ii) Safety nets shall extend outward from the outermost projection of the work surface as follows:

| Vertical distance from working levels to horizontal plane of net | Minimum required horizontal distance of outer edge of net from the edge of the working surface |
|------------------------------------------------------------------|------------------------------------------------------------------------------------------------|
| Up to 5 feet                                                     | 8 feet                                                                                         |
| More than 5 feet up to 10 feet                                   | 10 feet                                                                                        |
| More than 10 feet                                                | 13 feet                                                                                        |

- (iii) Safety nets shall be installed with sufficient clearance under them to prevent contact with the surface or structures below when subjected to an impact force equal to the drop test specified in (b)(iv) of this subsection.
- (iv) Safety nets and their installations shall be capable of absorbing an impact force equal to that produced by the drop test specified in (b)(iv)(A) and (B) of this subsection.
  - (A) Except as provided in (b)(iv)(B) of this subsection, safety nets and safety net installations shall be drop-tested at the job site after initial installation and before being used as a fall protection system, whenever relocated, after major repair, and at 6-month intervals if left in one place. The drop-test shall consist of a 400 pound (180 kg) bag of sand 30 ± 2 inches (76 ± 5 cm) in diameter dropped into the net from the highest walking/working surface at which employees are exposed to fall hazards, but not from less than 42 inches (1.1 m) above that level.
  - (B) When the employer can demonstrate that it is unreasonable to perform the drop-test required by (b)(iv)(A) of this subsection, the employer (or a designated competent person) shall certify that the net and net installation is in compliance with the provisions of (b)(iii) and (b)(iv)(A) of this subsection by preparing a certification record prior to the net being used as a fall protection system. The certification record must include an identification of the net and net installation for which the certification record is being prepared; the date that it was determined that the identified net and net installation were in compliance with (b)(iii) of this subsection and the signature of the person making the determination and certification. The most recent certification record for each net and net installation shall be available at the job site for inspection.
- (v) Defective nets shall not be used. Safety nets shall be inspected at least once a week for wear, damage, and other deterioration. Defective components shall be removed from service. Safety nets shall also be inspected after any occurrence which could affect the integrity of the safety net system.

---

**WAC 296-155-24510 (Cont.)**

- (vi) Materials, scrap pieces, equipment, and tools which have fallen into the safety net shall be removed as soon as possible from the net and at least before the next work shift.
  - (vii) The maximum size of each safety net mesh opening shall not exceed 36 square inches (230 cm<sup>2</sup>) nor be longer than 6 inches (15 cm) on any side, and the opening, measured center-to-center of mesh ropes or webbing, shall not be longer than 6 inches (15 cm). All mesh crossings shall be secured to prevent enlargement of the mesh opening.
  - (viii) Each safety net (or section of it) shall have a border rope for webbing with an minimum breaking strength of 5,000 pounds (22.2 kN).
  - (ix) Connections between safety net panels shall be as strong as integral net components and shall be spaced not more than 6 inches (15 cm) apart.
- (c) Catch platforms.
- (i) A catch platform shall be installed within 10 vertical feet of the work area.
  - (ii) The catch platforms width shall equal the distance of the fall but shall be a minimum of 45 inches wide and shall be equipped with standard guardrails on all open sides.
- (3) Positioning device systems. Positioning device systems and their use shall conform to the following provisions:
- (a) Positioning devices shall be rigged such that an employee cannot free fall more than 2 feet (.61 m).
  - (b) Positioning devices shall be secured to an anchorage capable of supporting at least twice the potential impact load of an employee's fall or 3,000 pounds (13.3 kN), whichever is greater.
  - (c) Connectors shall be drop forged, pressed or formed steel, or made of equivalent materials.
  - (d) Connectors shall have a corrosion-resistant finish, and all surfaces and edges shall be smooth to prevent damage to interfacing parts of this system.
  - (e) Connecting assemblies shall have a minimum tensile strength of 5,000 pounds (22.2 kN).
  - (f) Dee-rings and snap-hooks shall be proof-tested to a minimum tensile load of 3,600 pounds (16 kN) without cracking, breaking, or taking permanent deformation.
  - (g) Snap-hooks shall be a locking type snap-hook designed and used to prevent disengagement of the snap-hook by the contact of the snap-hook keeper by the connected member.
  - (h) Unless the snap-hook is designed for the following connections, snap-hooks shall not be engaged:
    - (i) Directly to webbing, rope or wire rope;
    - (ii) To each other;
    - (iii) To a dee-ring to which another snap-hook or other connector is attached;
    - (iv) To a horizontal lifeline; or

---

**WAC 296-155-24510 (Cont.)**

- (v) To any object which is incompatibly shaped or dimensioned in relation to the snap-hook such that unintentional disengagement could occur by the connected object being able to depress the snap-hook keeper and release itself.
- (i) Positioning device systems shall be inspected prior to each use for wear, damage, and other deterioration, and defective components shall be removed from service.
- (j) Body belts, harnesses, and components shall be used only for employee protection (as part of a personal fall arrest system or positioning device system) and not to hoist materials.
- (4) Droplines or lifelines used on rock scaling operations, or in areas where the lifeline may be subjected to cutting or abrasion, shall be a minimum of 7/8 inch wire core manila rope. For all other lifeline applications, a minimum of 3/4 inch manila or equivalent, with a minimum breaking strength of 5,000 pounds, shall be used.
- (5) Safety harnesses, lanyards, lifelines or droplines, independently attached or attended, shall be used while performing the following types of work when other equivalent type protection is not provided:
  - (a) Work performed in permit required confined spaces and other confined spaces shall follow the procedures as described in chapter 296-62 WAC, Part M.
  - (b) Work on hazardous slopes, or dismantling safety nets, working on poles or from boatswains chairs at elevations greater than six feet (1.83 m), swinging scaffolds or other unguarded locations.
  - (c) Work on skips and platforms used in shafts by crews when the skip or cage does not occlude the opening to within one foot (30.5 cm) of the sides of the shaft, unless cages are provided.
- (6) Canopies, when used as falling object protection, shall be strong enough to prevent collapse and to prevent penetration by any objects which may fall onto the canopy.  
[Statutory Authority: RCW 49.17.010, .040, .050. 00-14-058 (Order 99-43), § 296-155-24510, filed 07/03/2000, effective 10/01/2000. Statutory Authority: Chapter 49.17 RCW. 96-24-051, (Order 96-05), § 296-155-24510, filed 11/27/96, effective 02/01/97. 95-10-016, § 296-155-24510, filed 4/25/95, effective 10/1/95; 95-04-007, § 296-155-24510, filed 1/18/95, effective 3/1/95; 93-19-142 (Order 93-04), § 296-155-24510, filed 9/22/93, effective 11/1/93; 91-24-017 (Order 91-07), § 296-155-24510, filed 11/22/91, effective 12/24/91; 91-03-044 (Order 90-18), § 296-155-24510, filed 1/10/91, effective 2/12/91.]

**WAC 296-155-24515 Guarding of low pitched roof perimeters.**

- (1) General provisions. During the performance of work on low pitched roofs with a potential fall hazard greater than 10 feet, the employer shall ensure that employees engaged in such work be protected from falling from all unprotected sides and edges of the roof as follows:
  - (a) By the use of a fall restraint or fall arrest systems, as defined in WAC 296-155-24510; or
  - (b) By the use of a warning line system erected and maintained as provided in subsection (3) of this section and supplemented for employees working between the warning line and the roof edge by the use of a safety monitor system as described in WAC 296-155-24521.
  - (c) Mechanical equipment shall be used or stored only in areas where employees are protected by a warning line system, or fall restraint, or fall arrest systems as described in WAC 296-155-24510. Mechanical equipment may not be used or stored where the only protection is provided by the use of a safety monitor.

---

**WAC 296-155-24515 (Cont.)**

(2) Exceptions.

- (a) The provisions of subsection (1)(a) of this section do not apply at points of access such as stairways, ladders, and ramps, or when employees are on the roof only to inspect, investigate, or estimate roof level conditions. Roof edge materials handling areas and materials storage areas shall be guarded as provided in subsection (4) of this section.
- (b) Employees engaged in roofing on low-pitched roofs less than 50 feet wide, may elect to use a safety monitor system without warning lines.

*Note:* See Appendix A to Part C-1--Determining roof widths nonmandatory guidelines for complying with WAC 296-155-24515(2)(b).

(3) Warning lines systems.

- (a) Warning lines shall be erected around all sides of the work area.
  - (i) When mechanical equipment is not being used, the warning line shall be erected not less than six feet (1.8 meters) from the edge of the roof.
  - (ii) When mechanical equipment is being used, the warning line shall be erected not less than six feet (1.8 meters) from the roof edge which is parallel to the direction of mechanical equipment operation, and not less than 10 feet (3.1 meters) from the roof edge which is perpendicular to the direction of mechanical equipment operation.
- (b) The warning line shall consist of a rope, wire, or chain and supporting stanchions erected as follows:
  - (i) The rope, wire, or chain shall be flagged at not more than six foot (1.8 meter) intervals with high visibility material.
  - (ii) The rope, wire, or chain shall be rigged and supported in such a way that its lowest point (including sag) is no less than 36 inches (91.4 cm) from the roof surface and its highest point is no more than 42 inches (106.7 cm) from the roof surface.
  - (iii) After being erected, with the rope, wire or chain attached, stanchions shall be capable of resisting, without tipping over, a force of at least 16 pounds (71 Newtons) applied horizontally against the stanchion, 30 inches (0.76 meters) above the roof surface, perpendicular to the warning line, and in the direction of the roof edge.
  - (iv) The rope, wire, or chain shall have a minimum tensile strength of 200 pounds (90 kilograms), and after being attached to the stanchions, shall be capable of supporting, without breaking, the loads applied to the stanchions.
  - (v) The line shall be attached at each stanchion in such a way that pulling on one section of the line between stanchions will not result in slack being taken up in adjacent sections before the stanchion tips over.
- (c) Access paths shall be erected as follows:
  - (i) Points of access, materials handling areas, and storage areas shall be connected to the work area by a clear access path formed by two warning lines.

---

**WAC 296-155-24515 (Cont.)**

- (ii) When the path to a point of access is not in use, a rope, wire, or chain, equal in strength and height to the warning line, shall be placed across the path at the point where the path intersects the warning line erected around the work area.
- (4) Roof edge materials handling areas and materials storage. Employees working in a roof edge materials handling or materials storage area located on a low pitched roof with a ground to eave height greater than 10 feet shall be protected from falling along all unprotected roof sides and edges of the area.
  - (a) When guardrails are used at hoisting areas, a minimum of four feet of guardrail shall be erected on each side of the access point through which materials are hoisted.
  - (b) A chain or gate shall be placed across the opening between the guardrail sections when hoisting operations are not taking place.
  - (c) When guardrails are used at bitumen pipe outlet, a minimum of four feet of guardrail shall be erected on each side of the pipe.
  - (d) When safety belt/harness systems are used, they shall not be attached to the hoist.
  - (e) When fall restraint systems are used, they shall be rigged to allow the movement of employees only as far as the roof edge.
  - (f) Materials shall not be stored within six feet of the roof edge unless guardrails are erected at the roof edge.

[Statutory Authority: RCW 49.17.010, .040, .050. 00-14-058 (Order 99-43), § 296-155-24515, filed 07/03/2000, effective 10/01/2000. Statutory Authority: 96-24-051, (Order 96-05), § 296-155-24515, filed 11/27/96, effective 02/01/97. 95-10-016, § 296-155-24515, filed 4/25/95, effective 10/1/95; 91-24-017 (Order 91-07), § 296-155-24515, filed 11/22/91, effective 12/24/91; 91-03-044 (Order 90-18), § 296-155-24515, filed 1/10/91, effective 2/12/91.]

**WAC 296-155-24519 Reserved.**

[Statutory Authority: 96-24-051, (Order 96-05), § 296-155-24519, filed 11/27/96, effective 02/01/97. 95-10-016, § 296-155-24519, filed 4/25/95, effective 10/1/95.]

**WAC 296-155-24520 Leading edge control zone.**

- (1) When performing leading edge work, the employer shall ensure that a control zone be established according to the following requirements:
  - (a) The control zone shall begin a minimum of 6 feet back from the leading edge to prevent exposure by employees who are not protected by fall restraint or fall arrest systems.
  - (b) The control zone shall be separated from other areas of the low pitched roof or walking/working surface by the erection of a warning line system.
  - (c) The warning line system shall consist of wire, rope, or chain supported on stanchions, or a method which provides equivalent protection.
  - (d) The spacing of the stanchions and support of the line shall be such that the lowest point of the line (including sag) is not less than 36 inches from the walking/working surface, and its highest point is not more than 42 inches (106.7 cm) from the walking/working surface.
  - (e) Each line shall have a minimum tensile strength of 200 pounds (90 kilograms).

---

**WAC 296-155-24520 (Cont.)**

- (f) Each line shall be flagged or clearly marked with high visibility materials at intervals not to exceed 6 feet.
  - (g) After being erected with the rope, or chain attached, stanchions shall be capable of resisting without tipping over, a force of at least 16 pounds (71 Newtons) applied horizontally against the stanchions 30 inches (0.76 meters) above the roof surface, perpendicular to the warning line and in the direction of the roof edge.
- (2) When positive means of fall restraint as described in WAC 296-155-24510 (1)(a) through (d), or fall arrest as described in WAC 296-155-24510 (2) through (6) are not utilized, a safety monitor system as described in WAC 296-155-24521 shall be implemented to protect employees working between the forward edge of the warning line and the leading edge.

[Statutory Authority: RCW 49.17.010, .040, .050. 00-14-058 (Order 99-43), § 296-155-24520, filed 07/03/2000, effective 10/01/2000. Statutory Authority: 96-24-051, (Order 96-05), § 296-155-24520, filed 11/27/96, effective 02/01/97. 95-10-016, § 296-155-24520, filed 4/25/95, effective 10/1/95; 91-24-017 (Order 91-07), § 296-155-24520, filed 11/22/91, effective 12/24/91; 91-03-044 (Order 90-18), § 296-155-24520, filed 1/10/91, effective 2/12/91.]

**WAC 296-155-24521 Safety monitor system.**

- (1) A safety monitor system (SMS) may be used in conjunction with a warning line system as a method of guarding against falls during work on low pitched roofs and leading edge work only.
- (2) When selected, the employer shall ensure that the safety monitor system shall be addressed in the fall protection work plan, include the name of the safety monitor(s) and the extent of their training in both the safety monitor and warning line systems, and shall ensure that the following requirements are met.
- (3) The safety monitor system shall not be used when adverse weather conditions create additional hazards.
- (4) A person acting in the capacity of safety monitor(s) shall be trained in the function of both the safety monitor and warning lines systems, and shall:
  - (a) Be a competent person as defined in WAC 296-155-24503.
  - (b) Have control authority over the work as it relates to fall protection.
  - (c) Be instantly distinguishable over members of the work crew.
  - (d) Engage in no other duties while acting as safety monitor.
  - (e) Be positioned in relation to the workers under their protection, so as to have a clear, unobstructed view and be able to maintain normal voice communication.
  - (f) Not supervise more than eight exposed workers at one time.
  - (g) Warn the employee when it appears that the employee is unaware of a fall hazard or is acting in an unsafe manner.
- (5) Control zone:
  - (a) Workers shall be distinguished from other members of the crew by wearing highly visible, distinctive, and uniform apparel readily distinguishing them from other members of the crew only while in the control zone.

**WAC 296-155-24521 (Cont.)**

- (b) The employer shall ensure that each employee working in a control zone promptly comply with fall hazard warnings from safety monitors.

[Statutory Authority: RCW 49.17.010, .040, .050. 00-14-058 (Order 99-43), § 296-155-24521, filed 07/03/2000, effective 10/01/2000. Statutory Authority: 96-24-051, (Order 96-05), § 296-155-24521, filed 11/27/96, effective 02/01/97. 95-10-016, § 296-155-24521, filed 4/25/95, effective 10/1/95; 91-03-044 (Order 90-18), § 296-155-24521, filed 1/10/91, effective 2/12/91.]

**WAC 296-155-24522 Reserved.**

[Statutory Authority: 96-24-051, (Order 96-05), § 296-155-24522, filed 11/27/96, effective 02/01/97. 95-10-016, § 296-155-24522, filed 4/25/95, effective 10/1/95.]

**WAC 296-155-24523 Appendix A to Part C-1--Determining roof widths nonmandatory guidelines for complying with WAC 296-155-24515 (2)(b).**

- (1) This appendix serves as a guideline to assist employers complying with the requirements of WAC 296-155-24515 (2)(b). WAC 296-155-24515 (2)(b) allows the use of a safety monitoring system alone as a means of providing fall protection during the performance of roofing operations on low-sloped roofs 50 feet (15.25 m) or less in width. Each example in the appendix shows a roof plan or plans and indicates where each roof or roof area is to be measured to determine its width. Section views or elevation views are shown where appropriate. Some examples show “correct” and “incorrect” subdivisions of irregularly shaped roofs divided into smaller, regularly shaped areas. In all examples, the dimension selected to be the width of an area is the lesser of the two primary dimensions of the area, as viewed from above. Example A shows that on a simple rectangular roof, width is the lesser of the two primary overall dimensions. This is also the case with roofs which are sloped toward or away from the roof center, as shown in Example B.
- (2) Many roofs are not simple rectangles. Such roofs may be broken down into subareas as shown in Example C. The process of dividing a roof area can produce many different configurations. Example C gives the general rule of using dividing lines of minimum length to minimize the size and number of the areas which are potentially less than 50 feet (15.25 m) wide. The intent is to minimize the number of roof areas where safety monitoring systems alone are sufficient protection.
- (3) Roofs which are comprised of several separate, non-contiguous roof areas, as in Example D, may be considered as a series of individual roofs. Some roofs have penthouses, additional floors, courtyard openings, or similar architectural features; Example E shows how the rule for dividing roofs into subareas is applied to such configurations. Irregular, non-rectangular roofs must be considered on an individual basis, as shown in Example F.

**Example A**  
***Rectangular Shaped Roof***

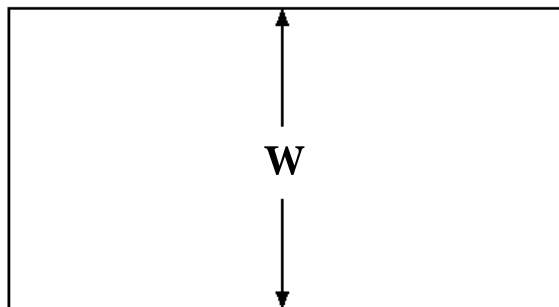

**PLAN VIEW**

WAC 296-155-24523 (Cont.)

**Example B**  
*Sloped Rectangular Shaped Roofs*

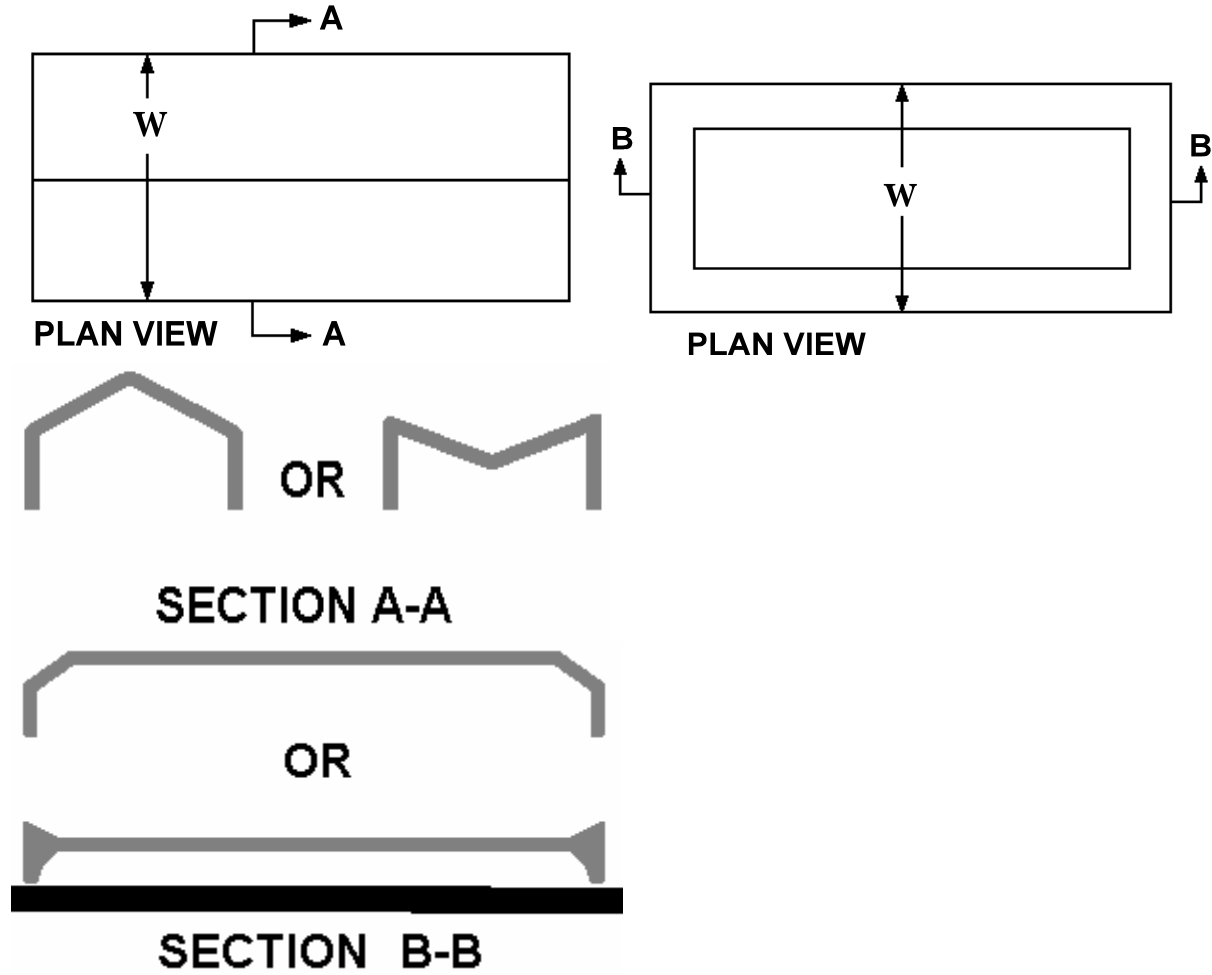

WAC 296-155-24523 (Cont.)

**Example C**  
*Irregularly Shaped Roofs With Rectangular Shaped Sections*

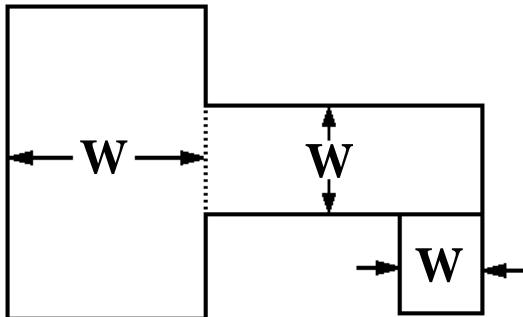

**Correct**

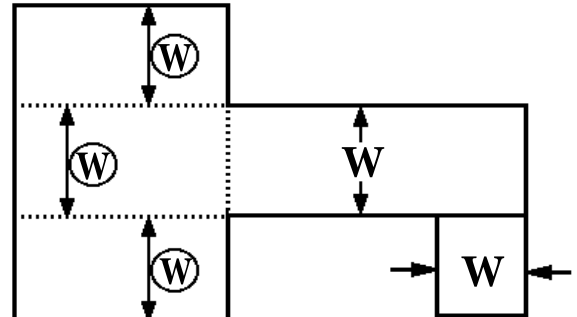

**Incorrect**

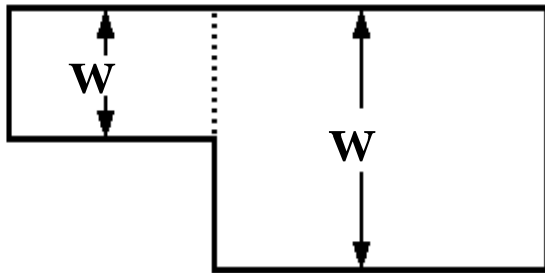

**Correct**

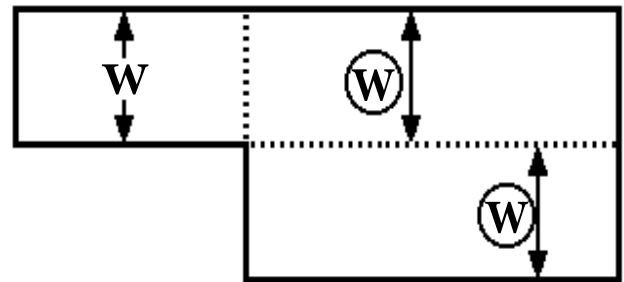

**Incorrect**

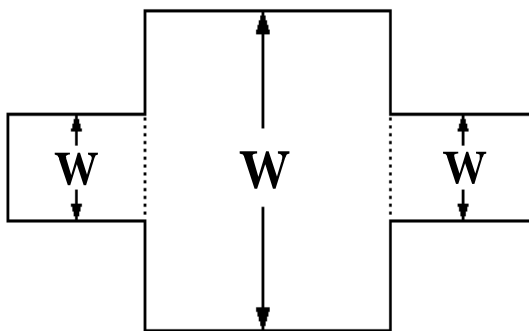

**Correct**

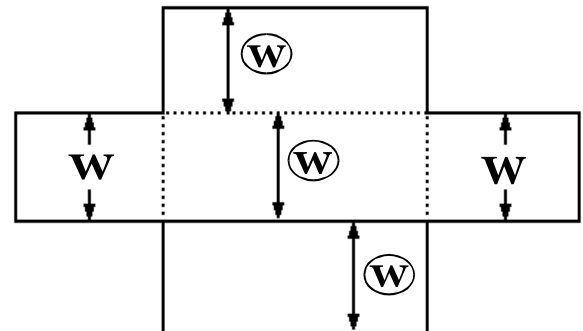

**Incorrect**

Such roofs are to be divided into subareas by using dividing lines of minimum length to minimize the size and number of the areas which are potentially less than or equal to 50 feet (15.25 meters) in width, in order to limit the size of roof areas where the safety monitoring system alone can be used (WAC 296-155-24515(2)(b)). Dotted lines are used in the examples to show the location of dividing lines.

Ⓜ denotes incorrect measurements of width.

WAC 296-155-24523 (Cont.)

**Example D**  
*Separate, Non-Contiguous Roof Areas*

1.

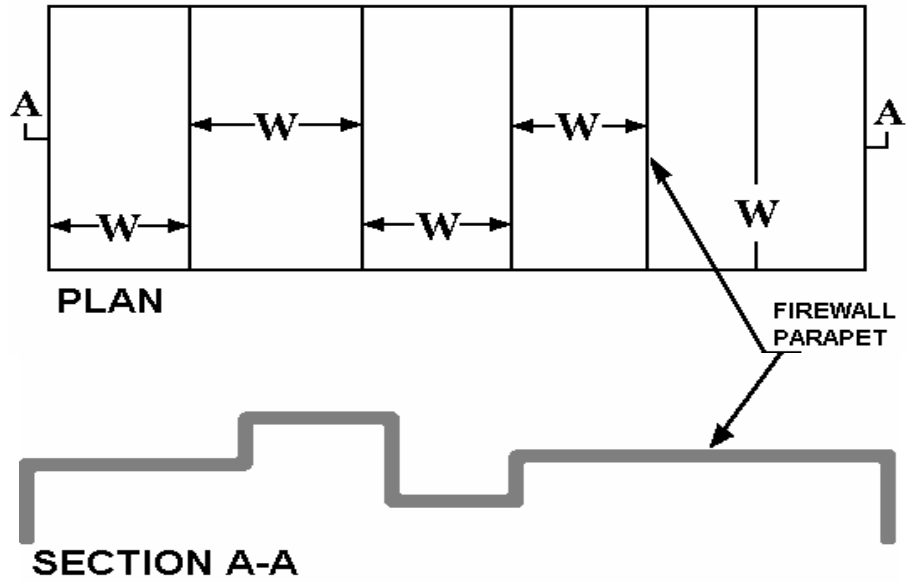

2.

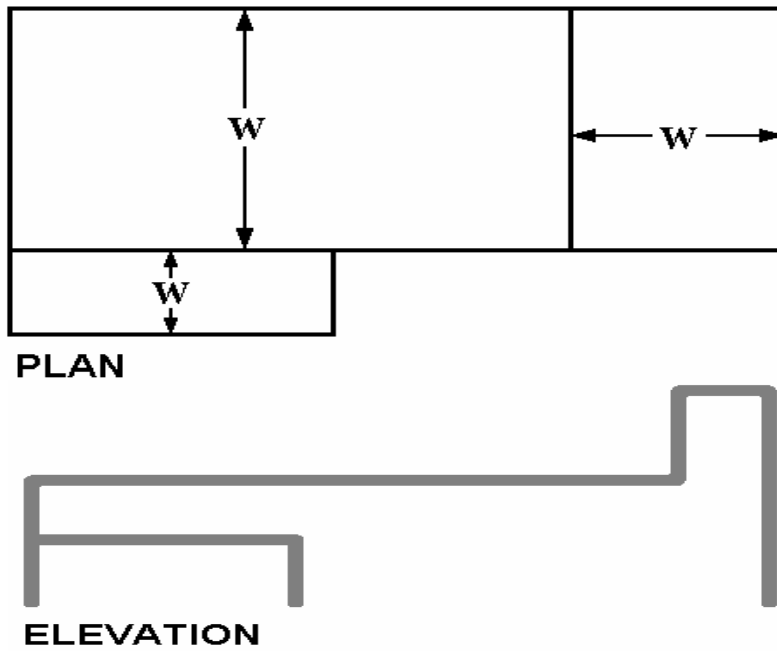

WAC 296-155-24523 (Cont.)

**Example E**  
*Roofs With Penthouses, Open Courtyards, Additional Floors, etc.*

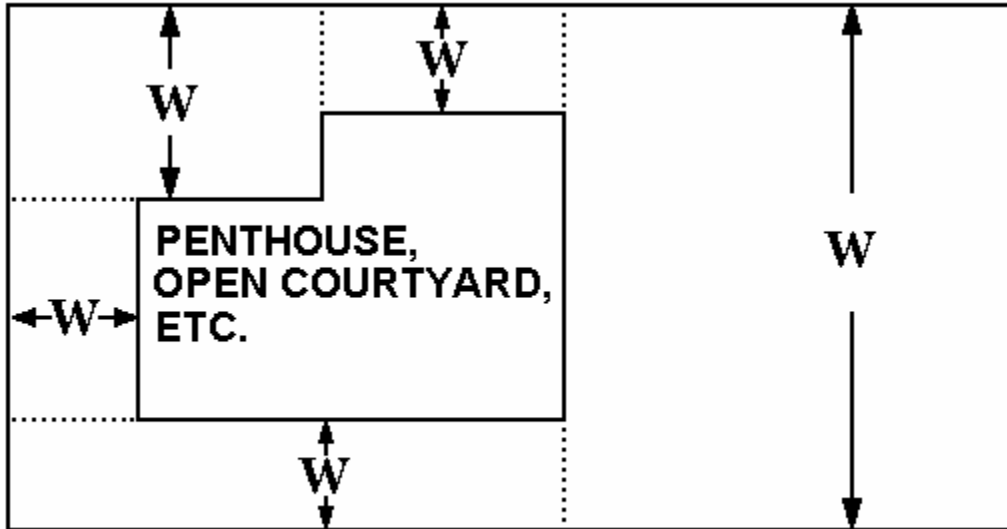

**CORRECT**

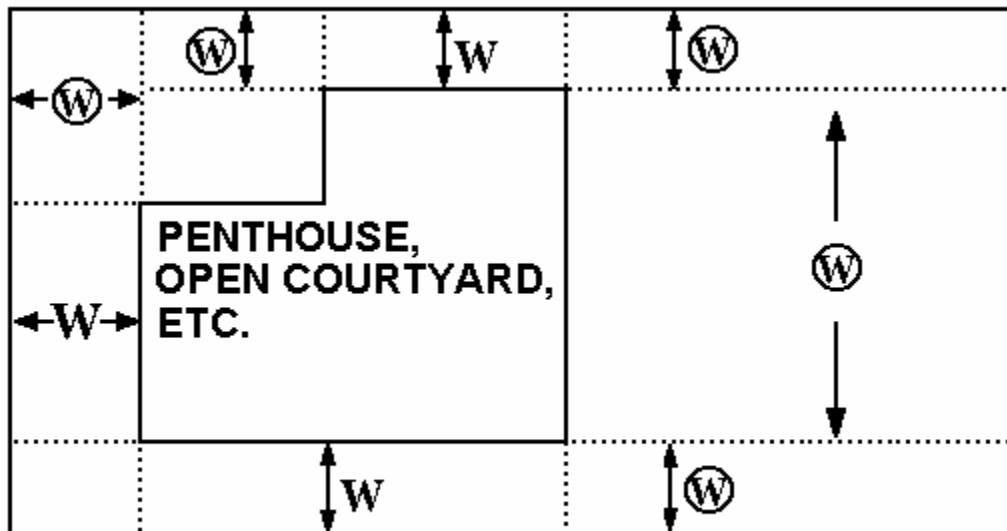

**INCORRECT**

Such roofs are to be divided into subareas by using dividing lines of minimum length to minimize the size and number of the areas which are potentially less than or equal to 50 feet (15.25 meters) in width, in order to limit the size of roof areas where the safety monitoring system alone can be used (WAC 296-155-24505 (2)(j)). Dotted lines are used in the examples to show the location of dividing lines.

Ⓜ denotes incorrect measurements of width.

WAC 296-155-24523 (Cont.)

**Example F**  
*Irregular, Non-Rectangular Shaped Roofs*

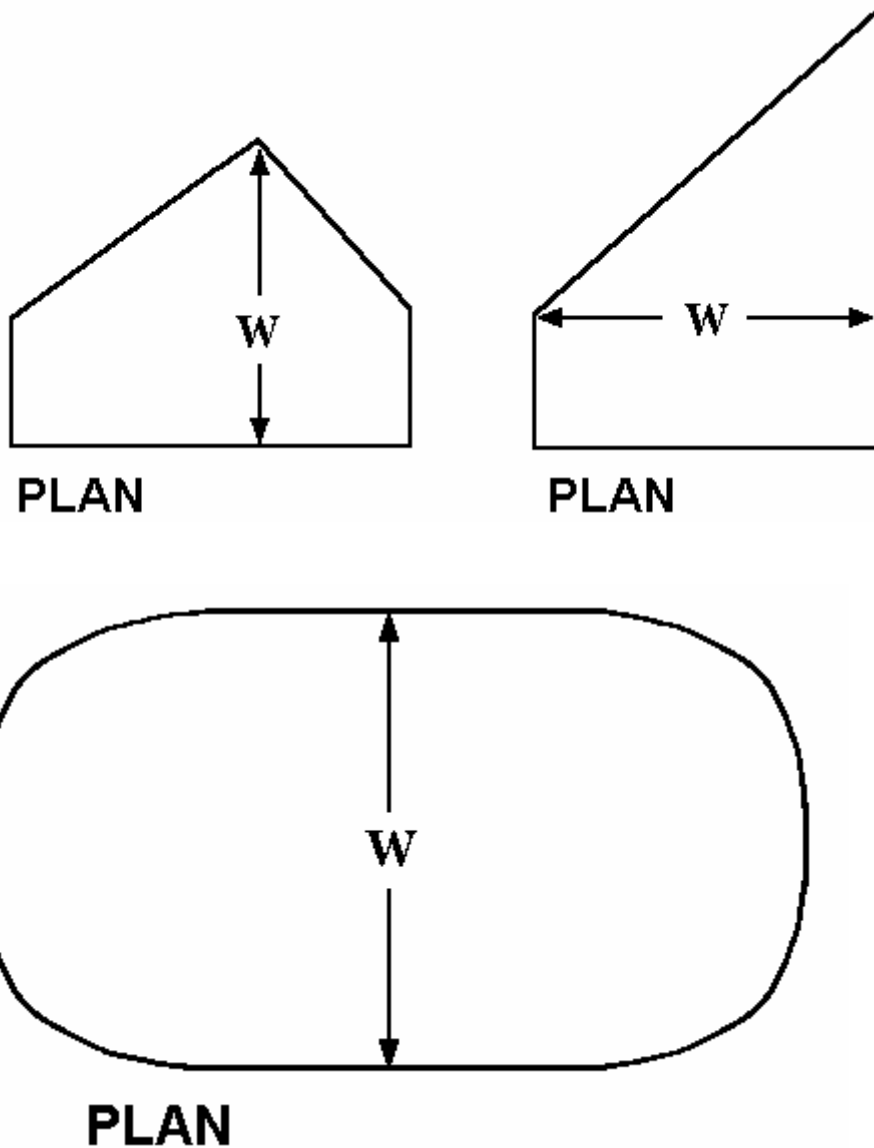

[Statutory Authority: Chapter 49.17 RCW. 96-24-051, (Order 96-05), § 296-155-24523, filed 11/27/96, effective 02/01/97. 95-10-016, § 296-155-24523, filed 4/25/95, effective 10/1/95.]

**WAC 296-155-24524 Reserved.**

[Statutory Authority: Chapter 49.17 RCW. 96-24-051, (Order 96-05); § 296-155-24524, filed 11/27/96, effective 02/01/97. 95-10-016, § 296-155-24524, filed 4/25/95, effective 10/1/95.]

**WAC 296-155-24525 Appendix B to Part C-1--Fall restraint and fall arrest (employer information only).** Additional standards that require the use of fall restraint and/or fall arrest protection for employees are listed below:

---

**WAC 296-155-24525 (Cont.)**

|                                                      |                                                                                                                                                           |
|------------------------------------------------------|-----------------------------------------------------------------------------------------------------------------------------------------------------------|
| Ladders                                              | WAC 296-155-480 (1)(r)<br>WAC 296-155-480 (1)(s)                                                                                                          |
| Scaffolds                                            | WAC 296-155-483(7)                                                                                                                                        |
| Boom Supported Elevating Work Platforms              | WAC 296-155-489                                                                                                                                           |
| Vehicle Mounted Elevated and Rotating Work Platforms | WAC 296-155-490 (2)(b)(v)                                                                                                                                 |
| Crane and Derrick Supported Work Platforms           | WAC 296-155-528 (6)(c)<br>WAC 296-155-528 (6)(d)<br>WAC 296-155-528 (7)(i)<br>WAC 296-155-528 (7)(j)<br>WAC 296-155-528 (7)(k)<br>WAC 296-155-528 (10)(h) |
| Open Sided Floors                                    | WAC 296-155-505 (6)(a) through (f)                                                                                                                        |
| Pile Driving                                         | WAC 296-155-620 (1)(i)                                                                                                                                    |
| Vertical Slip Forms                                  | WAC 296-155-688(9)                                                                                                                                        |
| Placing and Removal of Forms                         | WAC 296-155-689(4)                                                                                                                                        |
| Steel Erection Temporary Floors                      | WAC 296-155-705 (2)(b)                                                                                                                                    |

[Statutory Authority: RCW 49.17.010, .040, .050. 02-12-098, (Order 00-20), § 296-155-24525, filed 06/05/02, effective 08/01/02.  
Statutory Authority: RCW 49.17.010, .040, .050. 00-14-058 (Order 99-43), § 296-155-24525, filed 07/03/2000, effective 10/01/2000.  
Statutory Authority: Chapter 49.17.010, .040, .050, .060 RCW. 98-05-046 (Order 97-10), § 296-155-24525, filed 2/13/98, effective 4/15/98. RCW 49.17.040, 050 and 060. 96-24-051, § 296-155-24525, filed 11/27/96, effective 2/1/97. 95-10-016, § 296-155-24525, filed 4/25/95, effective 10/1/95. 91-03-044 (Order 90-18), § 296-155-24525, filed 1/10/91, effective 2/12/91.]